

A

A

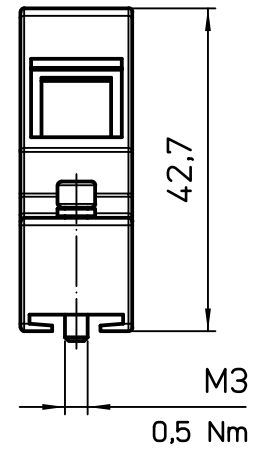
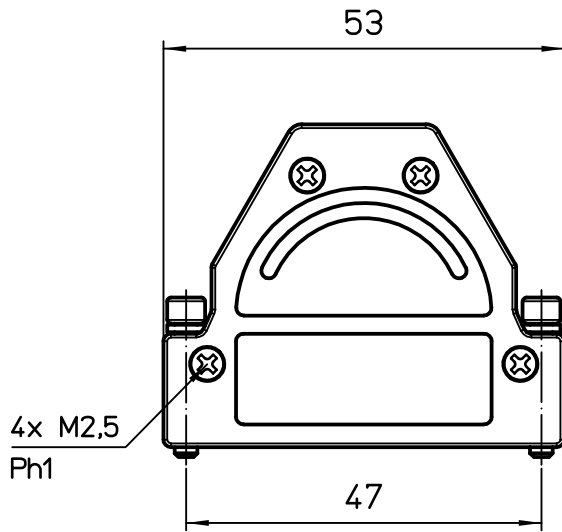

B

B

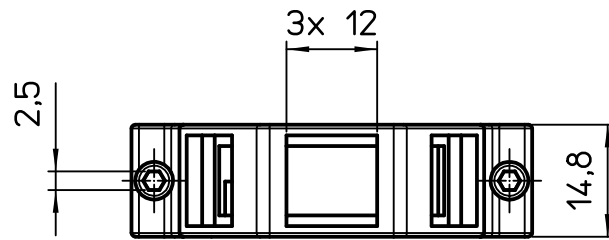

C

C

Diritti riservati All rights reserved

REV.	DATE	SIGNATURE		
Dimensions in mm		Simplified representation with dimensions without tolerance		
Original Size A4		MPTAV 25 D-Sub metal housing, 25P, top/side entry, with M3 fixing screws	Scale 1:1	
Date 01/03/22				
Sign. S. Diasparra				